



# Echotel® Models 344/345 Ultrasonic Non-Contact Transmitters for Level, Volume, or Open Channel Flow

## DESCRIPTION

---

Echotel® Models 344 and 345 are full-featured, ultrasonic non-contact transmitters that provide continuous measurement for liquid level, volume, or open channel flow applications. These versatile transmitters utilize the latest in microprocessor-based electronics along with powerful non-contact ultrasonic transducers, to provide level measurement that is not affected by changes in specific gravity, viscosity, or conductivity.

Model 344 and 345 are remote mounted transmitters that feature a front panel keypad, and a large 16-character alphanumeric display of all parameters. These transmitters are paired up with Kynar® and 316 stainless steel EchoMaster™ Ultrasonic Transducers that have extensive agency approvals for hazardous area locations.

## FEATURES

---

- Front panel keypad for ease of programming – no need to open enclosure after wiring
- 4–20 mA isolated (1,000  $\Omega$  load) and RS-232 outputs
- Four 10 amp SPDT relays allow for simple alarm configurations to complex pump control including lead/lag alternation of pumps
- Password code prevents unauthorized tampering of calibration parameters
- 16-character alphanumeric display of all parameters.
- Complete self-diagnostics assures unit is operating properly by checking all relays, outputs, and system functionality
- Temperature compensation integral to all ultrasonic transducers
- False target buffering eliminates signal interference from fixed obstructions in vessel



## APPLICATIONS

---

- Water and wastewater
- Slurries
- Viscous fluids
- Fuel oils
- Acids
- Caustics

# TECHNOLOGY

Model 344 and 345 systems consists of three main components: an ultrasonic transducer, a transmitter, and an interconnecting cable package.

The transducer contains a piezoelectric crystal that converts electrical signals generated by the transmitter into ultrasonic pulses. These pulses, or sound waves, are directed through the air toward the liquid surface. They are then reflected off the liquid surface as an echo, and

returned to the transducer. The piezoelectric crystal then converts the returned echo into an electrical signal which is analyzed by the transmitter. The elapsed time between the generation of the ultrasonic pulse and the return echo is proportional to the distance between the face of the transducer and the liquid surface. The distance value is used by the transmitter to compute level, volume, or flow in the engineering units selected by the user.

## ECHOMASTER TRANSDUCER

EchoMaster transducers are available in a wide variety of configurations to accommodate a broad range of industrial and municipal applications. The 344 uses the powerful 38 kHz Model 384 Kynar transducer, and is primarily used for level and volume applications. The 345 uses the

50 kHz Model 385 transducer that is available in either Kynar or 316 stainless steel. The higher frequency 50 kHz transducer makes the 345 well suited for open channel flow, and shorter range applications.

	Operating Frequency	Material	Insertion Lengths	NPT Process Connection	Housing
Model 384	38 kHz	Kynar	3" & 10"	1" or 2"	none, aluminum, or 316 stainless steel
Model 385	50 kHz	Kynar or 316 SS	3", 6", & 10"	¾" or 2"	

## TYPICAL MOUNTING CONFIGURATIONS

In Figure 1, the transducer is installed above the liquid surface, and the transmitter is mounted as far as 500 feet (152 meters) away. A minimum dead band distance must be allowed between the face of the transducer and the

maximum level attainable. This dead band distance is 18 inches (460 mm) for the Model 384 transducer, and 12 inches (305 mm) for the Model 385 transducer.

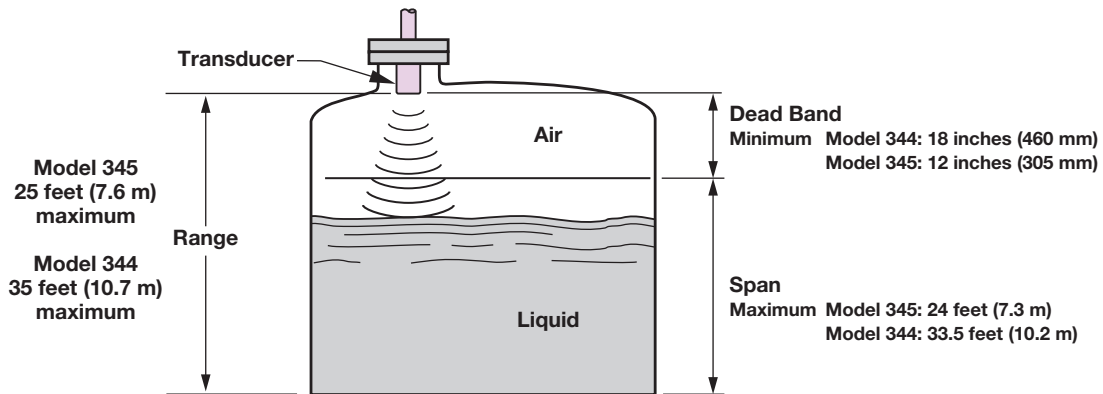
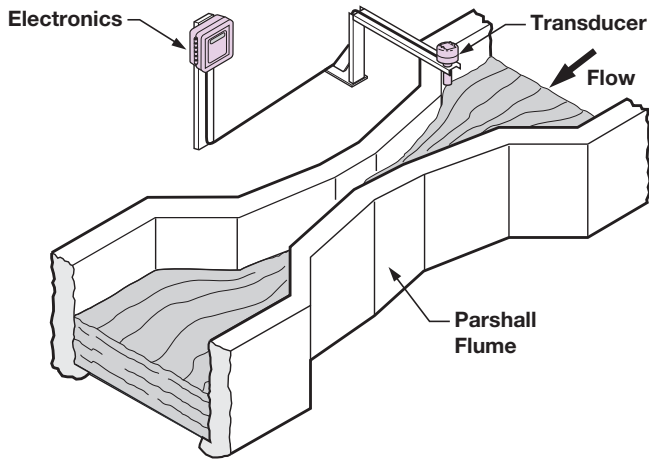

Figure 1  
Typical Transducer Mounting – Level/Volume

## TYPICAL MOUNTING CONFIGURATIONS

Figure 2 shows a typical transducer mounting on a bracket for open channel flow measurement. Figure 3 shows how the transducer can often be mounted further down in a wet well or sump if the liquid will never reach the top

of the vessel. This helps to keep the 12 degree ultrasonic beam away from pumps, ladders, side walls, or other obstructions in the vessel.



**Figure 2**  
Typical Transducer Mounting – Open Channel Flow

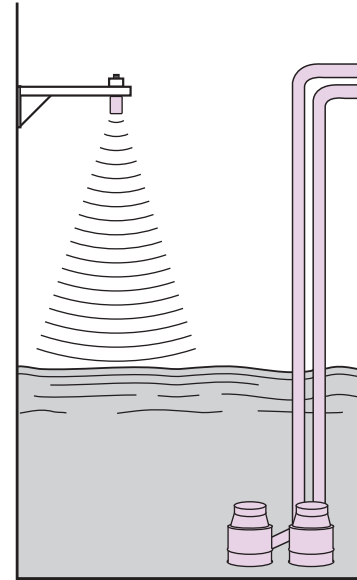

**Figure 3**  
Typical Transducer Mounting – Wet Well or Sump

## ULTRASONIC BEAM ANGLE

A 12° conical beam of ultrasonic energy is emitted from the face of the transducer. The transducer should be mounted in a location such that the ultrasonic signal does not touch the side walls or any other obstructions in the vessel. This is typically accomplished by using a bracket, half-coupling, or rigid conduit to mount the transducer in a spot where a strong echo can be received off of the

liquid surface. The chart below shows the distance the transducer should be located away from side walls and obstructions. The distances are based on a 6° beam radius at different heights above the liquid surface. Generally speaking, the transducer should be mounted one foot away for every 10 feet of height.

Distance from Transducer Face (feet)	12° Beam Diameter (feet)	Minimum Distance from Wall or Obstruction (inches)
3'	0.6'	4"
6'	1.3'	8"
9'	1.9'	11"
12'	2.5'	15"
15'	3.2'	19"
18'	3.8'	23"
21'	4.4'	26"
24'	5.0'	30"
27'	5.7'	34"
30'	6.3'	38"
33'	6.9'	42"

## FALSE TARGET DETECTION

When it is impossible to mount the transducer far enough away from obstructions in the vessel a unique false target detection feature can be used. This target detection mode programs the transducer to search for, and display, the distance of the target nearest the transducer. When this false target is detected, the level information of this unwanted target is stored in the buffer for false targets. This process is repeated until all of the possible false target locations are programmed into the transmitter or the buffer is full. A maximum of nine false targets can be programmed into the buffer.

Successful configuration of false targets will eliminate the possibility of unwanted target echoes being recognized as the real material level in the vessel. This technique is applicable to any obstruction which remains at the same horizontal plane (i.e., ladder rungs, pipes, tank braces, mixer blades, etc.) in the vessel.

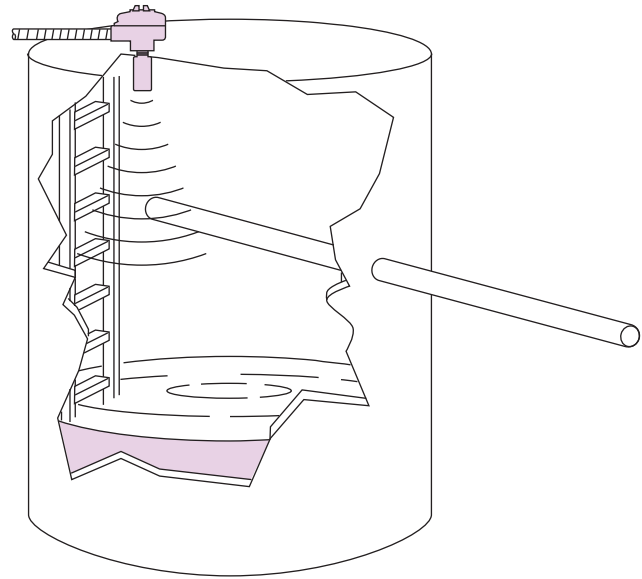

## TRANSMITTER SPECIFICATIONS

Supply voltage	120 VAC +10%/-15%, 50-60 Hz 240 VAC +10%/-15%, 50-60 Hz 24 VDC, ±20%
Power consumption	12 watts (without heater)
Fuse size	¼ amp replaceable, 250 VAC Slo-Blo® for AC units 2 amp replaceable, 250 VDC Slo-Blo for DC units
Output signal	4-20 mA isolated (1,000 Ω load), RS-232
Relays	Four 10 amp resistive, SPDT
Fail-safe	User selectable for analog and relay outputs
Display	Sixteen (16) character alphanumeric LCD
Keypad	Sixteen (16) button integral to front panel
Enclosure material	High-impact polycarbonate
Response time	2 seconds typical
Accuracy	± 0.25% of calibrated span
Humidity	95% Non-condensing
Ambient temperature	
without heater & thermostat*	-4° to +160° F (-20° to +70° C)
with heater & thermostat	-40° to +160° F (-40° to +70° C)

\* NOTE: The 31-day data logger has a +32° F (0° C) minimum when used without the heater and thermostat.

# TRANSDUCER SPECIFICATIONS

	Model 384	Model 385
Transducer frequency	38 kHz	50 kHz
Maximum range	35 feet (10.7 meters)	25 feet (7.6 meters)
Maximum span	33.5 feet (10.2 meters)	24 feet (7.3 meters)
Minimum dead band	18 inches (460 mm) from -40° to +163° F (-40° to +73° C)	12 inches (305 mm) from -40° to +140° F (-40° to +60° C)
		18 inches (460 mm) from +140° to +200° F (+60° to +93° C)
Operating temperature	-40° to +163° F (-40° to +73° C)	-40° to +200° F (-40° to +93° C)
Operating pressure	-10 to +50 psig (-0.69 to +3.45 bar)	
Temperature compensation	Automatic over the operating temperature range of the transducer	
Beam angle	12° conical	
Cable length	500 feet (152 meters) maximum between transducer and transmitter	

## AGENCY APPROVALS

AGENCY	MODEL APPROVED	APPROVAL CATEGORY	APPROVAL CLASSES
<b>FM</b> 	34X-X442-10X	Non-hazardous Non-incendive	NEMA 4X, IP65 Class I, II, III, Div. 2; Groups A, B, C, D, F, & G, T4A
	384-XKXX-0XX	Non-hazardous Explosion proof	NEMA 4X, IP65 Class I, II, III, Div. 1; Groups B, C, D, E, F, & G, T6
	385-XXXX-XXX	Non-hazardous	NEMA 4X, IP65
	385-XEXX-006 385-XEXX-010	Explosion proof	Class I, II, III, Div. 1; Groups B, C, D, E, F, & G, T6
	385-XEXX-003	Explosion proof	Class I, II, III, Div. 1; Groups A, B, C, D, E, F, & G, T6
	<b>CSA</b> 	34X-X442-10X	Non-hazardous
344-X442-10X		Non-incendive	Class I, II, III, Div. 2; Groups A, B, C, D, E, F, & G, T4A
384-XKXX-0XX		Non-hazardous	Type 4X enclosure
384-XK0X-0XX		Explosion proof	Class I, II, III, Div. 1; Groups B, C, D, E, F, & G
384-XK1X-0XX 384-XKYX-0XX		Explosion proof	Class I, II, III, Div. 1; Groups C, D, E, F, & G
385-XXXX-XXX		Non-hazardous	Type 4X enclosure
385-XE1X-0XX 385-XEYX-0XX		Explosion proof	Class I, II, III, Div. 1; Groups C, D, E, F, & G
385-XE0X-0XX		Explosion proof	Class I, II, III, Div. 1; Groups A, B, C, D, E, F, & G
385-XX1X-XXX		Non-incendive	Class I, II, III, Div. 2; Groups A, B, C, D, E, F, & G

# MEASUREMENT RANGE CALCULATIONS

Ultrasonic non-contact devices are typically rated for a maximum range in ideal conditions. Experience has shown that maximum range must be reduced for certain factors. Although the maximum range rating is somewhat conservative, each application must be evaluated for specific conditions in the tank.

## HOW TO CALCULATE

To evaluate the performance of a 344 or 345 in a particular application, use the chart on page 7, and follow the steps below:

1. Select one condition from each of the operating parameters that best describes your application.
2. Enter the corresponding performance multiplier value in the application column.
3. Multiply all of the selected values together.
4. Multiply step 3 by the maximum potential range of the unit. This yields a value that is the maximum allowable measurement range for the application.

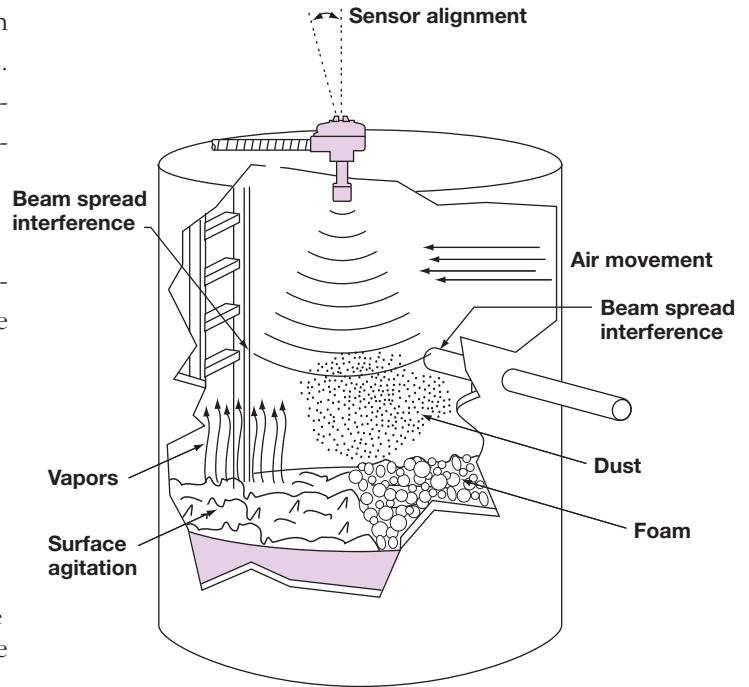

## EXAMPLE

The vessel is a closed-top tank, 26-feet tall and is filled from the top.

Surface agitation	Expect slight agitation from fill line: Performance multiplier 0.9
Vapor and steam	The process temperature is +130° F, slight vapor is expected: Performance multiplier 0.9
Beam interference	No interference exists: Performance multiplier 1.0
Transducer alignment	The transducer will be perpendicular to the liquid surface: Performance multiplier 1.0
Foam	None: Performance multiplier 1.0
Dust	None: Performance multiplier 1.0
Air movement	None: Performance multiplier 1.0
Ambient temperature	0 to +120° F: Performance multiplier 1.0
Pressure	Atmospheric pressure: Performance multiplier 1.0

Will the Model 344 work for this application?

## CALCULATION

Multiply all values in the application column:

$$0.9 \times 0.9 \times 1.0 \times 1.0 \times 1.0 \times 1.0 \times 1.0 \times 1.0 \times 35 \text{ feet (maximum)} = 28.35 \text{ feet}$$

The calculation yields 28.35 feet as the new maximum range. Since the tank is 26 feet tall, this application will give satisfactory results with the Model 344.

**NOTE:** The performance multipliers provided are conservative estimates. Since these factors are subjective, the values have been designed to provide very high confidence of system success. Contact the factory if there are any questions concerning the interpretation of any of these performance multipliers.

# MEASUREMENT RANGE CALCULATIONS

Operating Parameter	Condition	Performance Multiplier	Application
<b>SURFACE AGITATION:</b> Surface agitation or waves can degrade the performance. Moderate agitation results in only slight degradation of performance. The worst case is when the surface is a good reflector, but in the wrong direction. (See also transducer alignment.)	Smooth, glass-like surface	1.0	
	Slight agitation, choppiness	0.9	
	Heavy agitation	0.8	
	Slight vortex (6°)	0.7	
<b>VAPORS AND STEAM:</b> Vapors in the air space, above the process, become apparent, and cause problems when the liquid process temperature is well above the temperature of the airspace. The greater the difference, the more expected vapor problems. The problems result from condensation or layering in the sound path, both of which attenuate the sound signal, degrading performance.  To avoid these problems, ensure that the vessel is insulated so that vapors are less likely to condense. If a vent is used, be sure that the vent, which is where condensation will form, is well away from the transducer.	No condensation	1.0	
	Little condensation	0.9	
	Much condensation/ foggy appearance	0.8	
<b>BEAM SPREAD INTERFERENCE:</b> It is strongly recommended that nothing be allowed within the transducer's beam, except the liquid which is being monitored. Often, the signal from the liquid will be strong, compared to the signal from other sources, such as ladder rungs, filling process material, support struts, etc. For that reason, some applications may provide satisfactory results, even with interference. Interference from agitator blades is only an intermittent interference that usually has little effect on performance.  It is recommended there be no interference within the 6° half angle of the transducer beam. If interference is unavoidable, make the interference as far as possible from the transducer so that the real signal at the longest distance is stronger than the interference signal.	No interference	1.0	
	Agitator at speed less than 60 RPM	1.0	
	Agitator at speed greater than 60 RPM	Consult Factory	
	Interference outside 4°, far from transducer (in bottom third of range)	0.8	
	Interference outside 4°, near to transducer (in top third of range)	0.5	
<b>TRANSDUCER ALIGNMENT:</b> Optimum performance is obtained when the transducer is perfectly aligned. If the process is not perpendicular to the sound beam, the sound will not reflect properly back to the transducer. The effect is significant.	Beam perpendicular to liquid surface	1.0	
	Beam 4° off from perpendicular	0.5	
<b>FOAM:</b> Even small thicknesses of foam can attenuate the ultrasound and render the system inoperative. If possible, moving the transducer to an area in the tank where there is less foam will improve the performance. Thick, heavy-density foams can sometimes produce a reflection from the top of the foam. The multipliers shown at right are general guidelines. For further assistance consult the factory.	No foam	1.0	
	Light froth, less than 0.25" thick	0.8	
	Light foam, less than 0.5" thick	0.5	
	Light foam, more than 1" thick	0.1	
<b>DUST:</b> Dust attenuates the sound and results in poor performance. Even barely perceptible haze in the air can cause significant attenuation.	No dust	1.0	
	Haze, barely perceptible	0.7	
	Slight dust	0.4	
	Heavy dust	0.1	
<b>AIR MOVEMENT:</b> The movement of air, as possible in an open top vessel, can create a layer from which the sound will reflect. This will be most noticeable in applications where vapors or steam tend to form.	No air movement	1.0	
	Open vessel, but transducer below rim	0.8	
	Open air movement in sound path	0.7	
<b>AMBIENT TEMPERATURE:</b> The ambient temperature can have a significant effect on the sound and on the transducer's capability to transmit and receive sound. The most noticeable effect on the transducer is at the temperature extremes.	-20° to +140° F (-29° to +50° C)	1.0	
	-40° to -20° F (-40° to -29° C)	0.9	
	+140° to +160° F (+50 to +70° C)	0.9	
<b>PRESSURE:</b> Sound requires air molecules to be able to travel. Sound will not travel in a vacuum. Likewise, higher pressures will allow the sound to continue without decay, which can cause problems with multiple echoes.	-10 to +50 PSIG (0.689 to +3.45 bar)	1.0	
	Pressures outside above rating	Consult Factory	
<b>Multiply all values together in the application column</b>			
<b>Multiply by maximum potential range (35 feet for Model 344 or 25 feet for Model 345 )</b>			<b>X</b>
<b>Maximum allowable measurement range for this application</b>			<b>=</b>

# DIMENSIONAL SPECIFICATIONS

INCHES (MM)

## MODEL 344 & 345 TRANSMITTERS

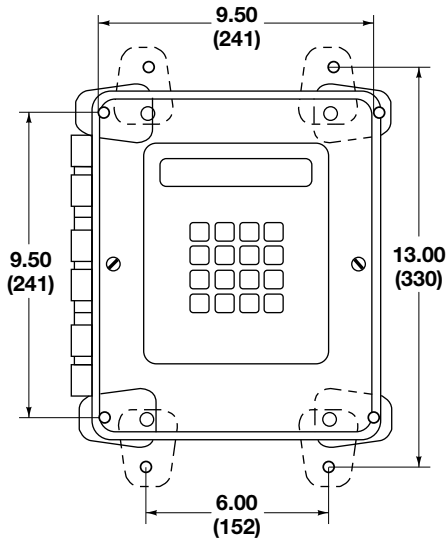

Front View

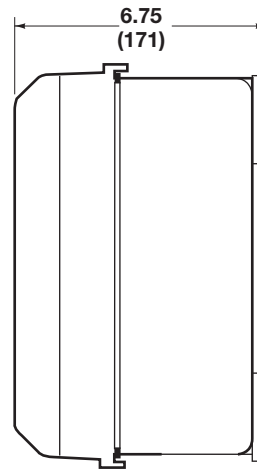

Side View

## MODEL 385 TRANSDUCERS

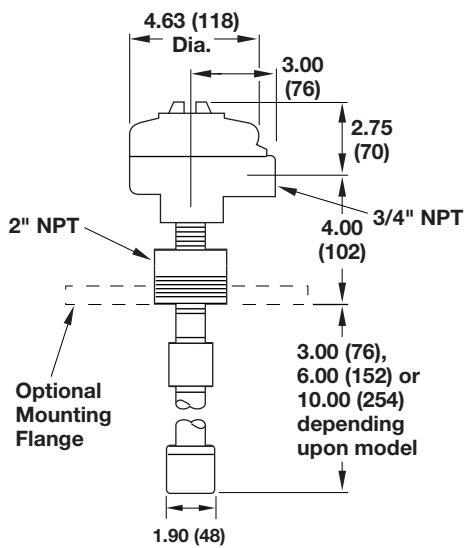

2" NPT Transducer with Housing

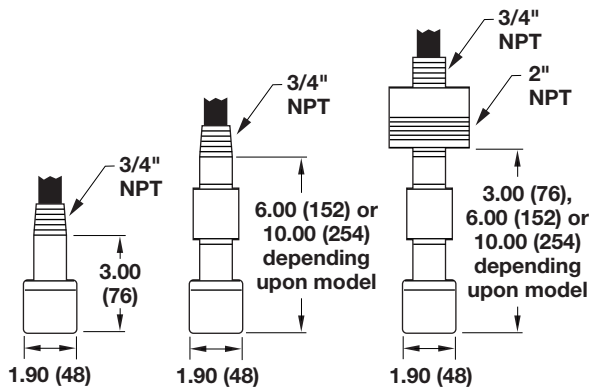

3/4" and 2" NPT Transducer without Housing



# DIMENSIONAL SPECIFICATIONS

INCHES (MM)

## MODEL 384 TRANSDUCERS

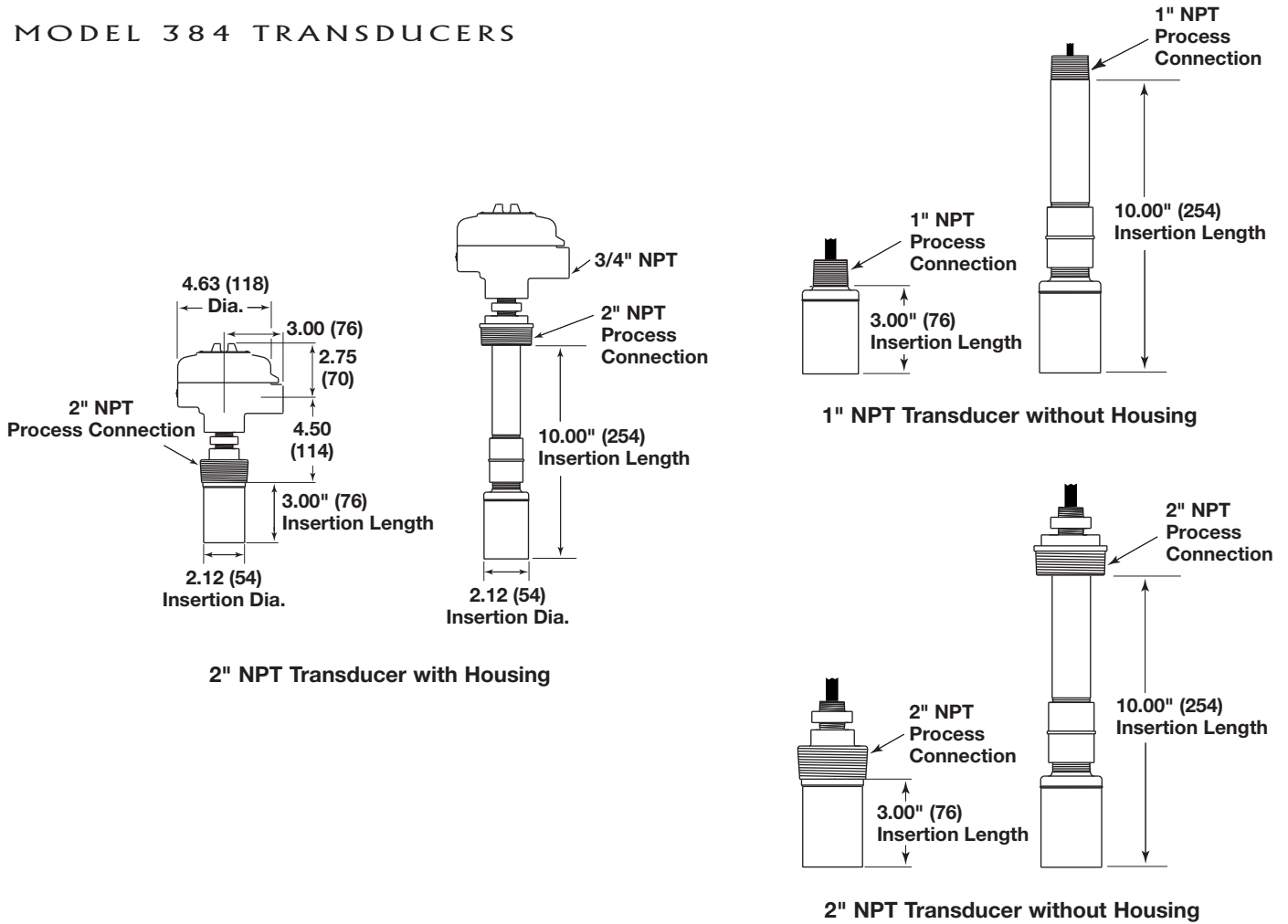

## OPTIONAL MOUNTING BRACKETS

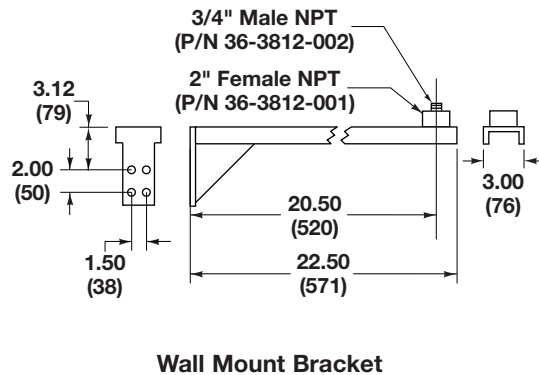
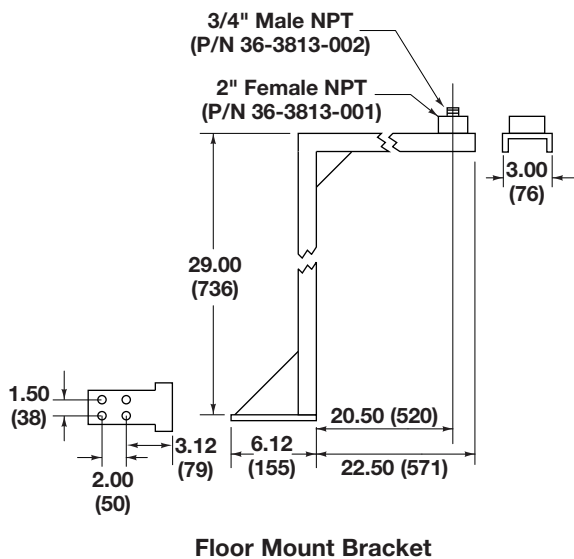

# TRANSMITTER

## MODEL NUMBER

Models available for quick shipment, usually within one week after factory receipt of a complete purchase order, through the Expedite Ship Plan (ESP)

### BASIC MODEL

344	Ultrasonic non-contact transmitter, used with Model 384 transducer
345	Ultrasonic non-contact transmitter, used with Model 385 transducer

### INPUT POWER

0	120 VAC, 50/60 Hz
1	240 VAC, 50/60 Hz
2	24 VDC
3	120 VAC with heater and thermostat
4	240 VAC with heater and thermostat

### SPECIAL OPTIONS

0	None
1	Mechanical totalizer
2	31-day data logger
3	Mechanical totalizer & 31-day data logger

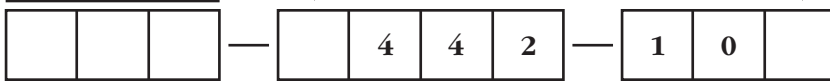

# MODEL 384 38 KHZ TRANSDUCER

## MODEL NUMBER

### PROCESS CONNECTION

2	1" NPT, not available with transducer housing code 1 or Y
5	2" NPT

### TRANSDUCER MATERIAL

K	Kynar
---	-------

### TRANSDUCER HOUSING

0	No housing, 35' (10.7 m) of cable potted into transducer
1	Cast aluminum, NEMA 4X/7/9 housing with 3/4" NPT single conduit, connecting cable ordered separately
Y	316 stainless steel, NEMA 4X/7/9 housing with 3/4" NPT single conduit connecting cable ordered separately

### TRANSDUCER MOUNTING BRACKET

0	No mounting bracket
3	Wall mount bracket for 2" NPT process connection only
4	Floor mount bracket for 2" NPT process connection only

### TRANSDUCER INSERTION LENGTH

003	3" (76 mm) length
010	10" (254 mm) length



# MODEL 385 50 kHz TRANSDUCER

## MODEL NUMBER

### PROCESS CONNECTION

1	3/4" NPT, not available with transducer housing code 1 or Y
5	2" NPT

### TRANSDUCER MATERIAL

K	Kynar
E	316 stainless steel (for use in hazardous environments, refer to agency approvals)

### TRANSDUCER HOUSING

0	No housing, 35' (10.7 m) of cable potted into transducer
1	Cast aluminum, NEMA 4X/7/9 housing with 3/4" NPT single conduit, connecting cable ordered separately
Y	316 stainless steel, NEMA 4X/7/9 housing with 3/4" NPT single conduit connecting cable ordered separately

### TRANSDUCER MOUNTING BRACKET

0	No mounting bracket
1	Wall mount bracket for 3/4" NPT process connection only
2	Floor mount bracket for 3/4" NPT process connection only
3	Wall mount bracket for 2" NPT process connection only
4	Floor mount bracket for 2" NPT process connection only

### TRANSDUCER INSERTION LENGTH

003	3" (76 mm) length
006	6" (152 mm) length
010	10" (254 mm) length

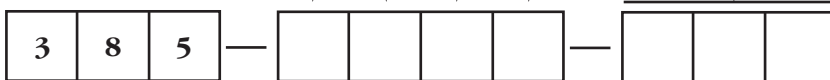

## CONNECTING CABLE

### PART NUMBER

### CABLE LENGTH IN FEET

10 feet (3 m) minimum, 500 feet (152 m) maximum length  
 Example: 12 foot cable length = Code 012

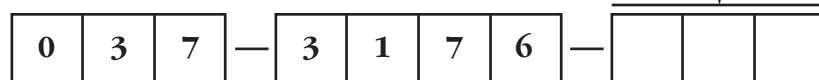

## QUALITY

---



The quality assurance system in place at Magnetrol® guarantees the highest level of quality throughout the company. MAGNETROL is committed to providing full customer satisfaction both in quality products and quality service.

The MAGNETROL quality assurance system is registered to ISO 9001 affirming its commitment to known international quality standards providing the strongest assurance of product/service quality available.

## ESP

---

### **E**xpedite **S**hip **P**lan

Several ECHOTEL Model 344 and 345 Ultrasonic Transmitters are available for quick shipment, usually within one week after factory receipt of a complete purchase order, through the Expedite Ship Plan (ESP). Models covered by ESP service are color coded in the model selection charts.

To take advantage of ESP, simply match the color coded model number codes (standard dimensions apply).

ESP service may not apply to orders of ten units or more. Contact your local representative for lead times on larger volume orders, as well as other products and options.

## WARRANTY

---



All MAGNETROL electronic level and flow controls are warranted free of defects in materials or workmanship for one full year from the date of original factory shipment. If returned within the warranty period; and, upon factory inspection of the control, the cause of the claim is determined to be covered under the warranty; then, MAGNETROL will repair or replace the control at no cost

to the purchaser (or owner) other than transportation.

MAGNETROL shall not be liable for misapplication, labor claims, direct or consequential damage or expense arising from the installation or use of equipment. There are no other warranties expressed or implied, except special written warranties covering some MAGNETROL products.

For additional information, see Instruction Manual 51-629.

---



5300 Belmont Road • Downers Grove, Illinois 60515-4499 • 630-969-4000 • Fax 630-969-9489 • [www.magnetrol.com](http://www.magnetrol.com)  
145 Jardin Drive, Units 1 & 2 • Concord, Ontario Canada L4K 1X7 • 905-738-9600 • Fax 905-738-1306  
Heikensstraat 6 • B 9240 Zele, Belgium • 052 45.11.11 • Fax 052 45.09.93  
Regent Business Ctr., Jubilee Rd. • Burgess Hill, Sussex RH15 9TL U.K. • 01444-871313 • Fax 01444-871317

Copyright © 2011 MAGNETROL INTERNATIONAL, INCORPORATED. All rights reserved. Printed in the USA.

Performance specifications are effective with date of issue and are subject to change without notice.

MAGNETROL, MAGNETROL logotype and ECHOTEL are registered trademarks of MAGNETROL INTERNATIONAL, INCORPORATED.

**BULLETIN: 51-129.6**  
**EFFECTIVE: May 2004**  
**SUPERSEDES: November 2002**